

Article number: 0110076

Description: Retaining ring JS 60x3  
Springsteel

## Measures

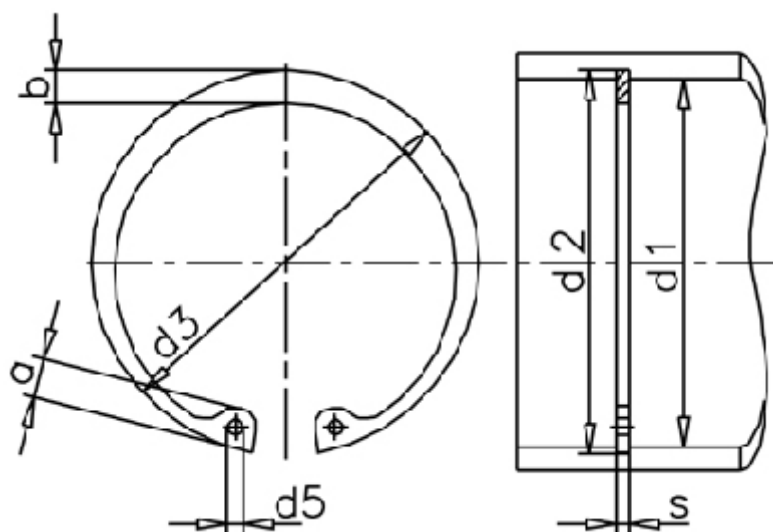

a max	= 8.5	Description	= JS 60	t	= 1.50
AN mm <sup>2</sup>	= 290	FN kN	= 48.3	tol	= 0.30
B	= 2.25	FRg kN	= 29.2	tol	= +1,10 -0,46
b	= 5.4	FR kN	= 137.0	tol	= -0.08
d1	= 60	g	= 2.0	Tong	= ZGJ-3
d2	= 63.0	m min	= 3.15	Weight kg/1000	= 15.9
d3	= 64.2	Nominal drive	= 4.5		
d5 min	= 2.5	s	= 3.00		